

TOSHIBA
Leading Innovation >>>

AIR CONDITIONER (MULTI-SPLIT TYPE)
Owner's Manual

R32 or R410A

Not for general public use

Indoor unit

Model name: _____

<Concealed Duct Type>

RAS-M07U2DVG-E

RAS-M10U2DVG-E

RAS-M13U2DVG-E

RAS-M16U2DVG-E

RAS-M22U2DVG-E

RAS-M24U2DVG-E

English

Español

Français

Italiano

Deutsch

Português

Ελληνικά

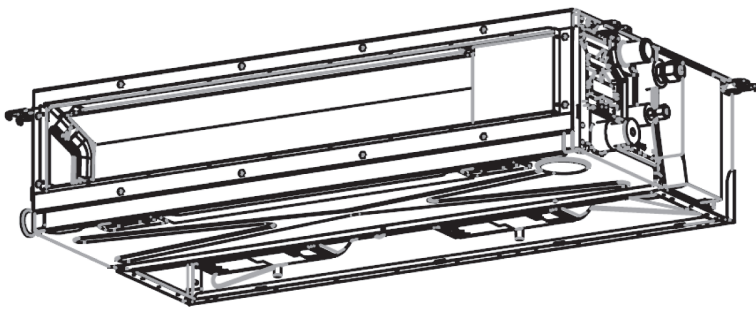

E0X7300401-00

ADOPTION OF R32/R410A REFRIGERANT

This Air Conditioner has adopted a HFC (R32/R410A) which does not destroy the ozone layer.
Be sure to combine with an outdoor unit for the R32/R410A refrigerant.

PRECAUTIONS FOR SAFETY

The manufacturer shall not assume any liability for the damage caused by not observing the description of this manual.

Store this owner's manual in a location where it can be easily accessed when needed.

Be sure to read this owner's manual carefully before operating.



It is recommended that maintenance be performed by a specialist when the unit has been operated for a long time.

This appliance can be used by children aged from 8 years and above and persons with reduced physical, sensory or mental capabilities or lack of experience and knowledge if they have been given supervision or instruction concerning use of the appliance in a safe way and understand the hazards involved.

Children shall not play with the appliance. Cleaning and user maintenance shall not be made by children without supervision.

Be sure to follow the precautions provided here to avoid safety risks.







The symbols and their meanings are shown below.

 DANGER	It indicates that incorrect use of this unit can result in a high possibility of severe injury(*1) or death.
 WARNING	It indicates that incorrect use of this unit may cause severe injury or death.
 CAUTION	It indicates that incorrect use of this unit may cause personal injury(*2), or property damage(*3).

*1: A severe injury refers to blindness, injury, burns (hot or cold), electrical shock, bone fracture, or poisoning that leaves aftereffects and requires hospitalization or extended out-patient treatment.

*2: Personal injury means a slight accident, burn, or electrical shock which does not require admission or repeated hospital treatment.

















*3: Property damage means greater damage which affects assets or resources.

















 Never do	 Beware of rotating parts
 Electrical hazard. Contact with water will cause electric shock. DO NOT touch with wet hands.	 Risk of finger injury
 Always follow the instructions	 Do not get the product wet

DANGER









 Do not install, repair, open or remove the cover. It may expose you to dangerous voltages. Ask the dealership or the specialist to do this.

 Turning off the power supply will not prevent potential electric shock.





	The appliance shall be installed in accordance with national wiring regulation.
	Means for disconnection from the supply having a contact separation of at least 3 mm in all poles must be incorporated in the fixed wiring.
	Do not place a spray can near the air outlet grille less than 1 m. The warm air from indoor and outdoor units may cause an explosion of the spray can.
 WARNING	
	Installation must be requested from the supplying retail dealership or professional installation vendors. Installation requires special knowledge and skill. If customers install on their own, it can be a cause of fire, electric shock, injury or water leakage.
	Do not use any refrigerant different from the one specified for complement or replacement. Otherwise, abnormally high pressure may be generated in the refrigeration cycle, which may result in a failure or explosion of the product or an injury to your body.
	Do not disassemble, modify or relocate the unit by yourself. It may become the cause of fire, electric shock, or water leakage. For repair or relocation, please request service from the supplying retail dealership.
	When relocating or repairing the unit, please contact the supplying retail dealership. When there is a kink in the wiring, it may be the cause of electric shock or fire.
	Do not select a location for installation where flammable gas may leak. If there is any gas leakage or accumulation around the unit, it can be a cause of fire.
	Do not select a location for installation where there may be excessive water or humidity, such as a bathroom. Deterioration of insulation may be a cause of electric shock or fire.
	Earth work should be requested from the supplying retail dealership or professional vendors. Insufficient grounding work may be the cause of electric shock. Do not connect the earth wire to a gas pipe, water pipe, lightning conductor, or telephone earth wire.
	You must use an independent power outlet for the power supply. If a power outlet other than the independent outlet is used, it may cause a fire.
	Check that the circuit breaker is installed correctly. If the circuit breaker is not properly installed, it may cause an electric shock. To check the installation method, please contact the supplying retail dealership or the professional vendor who installed the unit.
	During an error (such as a burning odor, not cooling, or not warming), stop operating the unit and turn off the circuit breaker. Continuous operation may be a cause of fire, or electric shock. Please request repair or service from the supplying retail dealership.
	Do not turn ON/OFF the circuit breaker or operate buttons with a wet hand. It may be a cause of electric shock.
	Do not insert any material (metal, paper, or water, etc.) into the air outlet or air intake opening. Fan may be rotating at high speed inside or there are high voltage sections, which may cause an injury or electric shock.
	Do not clean the air filter (Locally Procured) by yourself, it may become the cause of an electric shock or an injury. Request the service of the supplying retail dealership.

	<p>When the air-conditioning unit does not cool or warm, there may be a leakage of refrigerant. Please consult the supplying retail dealership.</p> <p>The refrigerant used in the air-conditioning unit is safe. It will not leak under normal operating conditions, but if it leaks into the room and contacts a heat source such as a heater, or stove, it may cause a harmful reaction.</p>
	<p>When water or other foreign substances enter the internal parts, stop operating the unit immediately and turn off the circuit breaker. Operating the unit continuously may cause fire or electric shock. Please contact the supplying retail dealership for repair.</p>
	<p>Do not clean the inside of the air-conditioning unit yourself. Please request internal cleaning of the air-conditioning unit from the supplying retail dealership. Incorrect cleaning may cause breakage of resin parts or insulation defects of electrical parts, causing water leakage, electric shock or fire.</p>
	<p>Do not damage or modify the power cable. Do not connect the cable midway, or use a multiple outlet extension cord that is shared by other devices. Failure to do so may cause fire.</p>
	<p>Do not place heavy objects on the power cable, expose it to heat, or pull it. To do so may cause electrical shock or fire.</p>
	<p>Do not expose your body directly to cool air for a long time.</p>
	<p>Do not insert your finger or any article into the air inlet/outlet.</p>
 CAUTION	
	<p>Do not touch the body of the unit. It may cause an electric shock or an injury.</p>
	<p>Ensure that drained water is discharged. When the discharging water process is not sufficient, water may leak, causing water damage to furniture.</p> <p>To check that the installation method used is correct, please contact the supplying retail dealership or the professional vendor who installed the unit.</p>
	<p>If the indoor unit piping outlet is exposed due to relocation, close the opening. Touching internal electrical parts may cause injury or electric shock.</p>
	<p>Do not wash the main air-conditioning unit with water. It may cause an electric shock.</p>
	<p>Do not place any containers such as a vase containing fluid on the unit. It might cause water to enter the unit and deteriorate the electrical insulation, causing an electric shock.</p>
	<p>When using the unit in a closed room, or operating with other combustion appliances, make sure to open a window occasionally for ventilation. Insufficient ventilation may cause suffocation due to a lack of oxygen.</p>
	<p>Do not use combustion appliances in the direct flow of the air from the air-conditioning unit. Poor combustion of a combustion appliance may cause suffocation.</p>
	<p>Avoid operating for long periods in a high humidity environment (over 80%) such as with the windows or doors open. There may be condensation on the indoor unit and droplets may fall onto the furniture.</p>
	<p>When the unit won't be used for a long time, turn off the main switch or the circuit breaker.</p>

EN

	At least once a year check if the mounting table of the outdoor unit is damaged or not. If a damaged state is ignored, the unit may fall or over-turn, causing an injury.
	Do not stand on the outdoor unit or place anything on the unit. It may be the cause of injury due to falling or over-turning. Any damage to the unit may cause an electric shock or fire.
	Do not place anything around the outdoor unit or allow fallen leaves to accumulate around it. If there are fallen leaves, small animals could enter and contact internal electrical parts, causing a failure or fire.
	Do not place animals and plants in places where wind from the air-conditioning unit flows directly. It may have a negative influence on the animal or plant.
	Do not use for special applications such as storage of food or animals, or to display plants, precision devices, or art objects. Do not use on ships or in other vehicles. It may cause a failure in the air-conditioning unit. In addition, it may damage these items.
	Do not place other electrical appliances or furniture under the unit. Water droplets might fall, causing damage or failure.
	When performing maintenance, you must stop operating the unit and turn off the circuit breaker. Since the fan inside may be rotating at high speed, it may cause an injury.
	When you hear thunder and there might be a lightning strike, stop operating the unit and disconnect the circuit breaker. If lightning strikes, it may cause a failure.

- Batteries for remote control unit:
 - Should be inserted with correct polarity (+) and (-).
 - Should not be recharged.
 - Do not use batteries for which the “Recommended usage period” has expired.
 - Do not keep used batteries inside the remote control unit.
 - Do not mix different types of batteries, or mix new batteries with old ones.
 - Do not directly solder the batteries.
 - Do not short-circuit, disassemble, heat, or throw batteries into a fire. If batteries are not disposed of correctly, they may burst or be the cause of fluid leakage, resulting in burns or injuries. If touching the fluid, wash thoroughly with water. If it touches devices, wipe off to avoid direct contact.
 - Do not place within reach of small children. If a battery is swallowed, consult a doctor immediately.
- When you press CLOCK ●, CHECK ●, FILTER ● and RESET ● button, do not let any foreign substances enter and remain inside of the remote control.

	WARNING (Risk of fire)	This mark is for R32 refrigerant only. Refrigerant type is written on nameplate of outdoor unit. In case that refrigerant type is R32, this unit uses a flammable refrigerant. If refrigerant leaks and comes in contact with fire or heating part, it will create harmful gas and there is risk of fire.
	Read the OWNER'S MANUAL carefully before operation.	
	Service personnel are required to carefully read the OWNER'S MANUAL and INSTALLATION MANUAL before operation.	
	Further information is available in the OWNER'S MANUAL, INSTALLATION MANUAL, and the like.	

1 SIGNAL RECEIVING UNIT DISPLAY

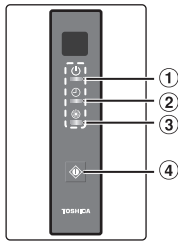

- ① OPERATION (Green)
- ② TIMER (Orange)
- ③ PRE.DEF (Preheat/Defrost/Self Cleaning) (Orange)
- ④ TEMPORARY button

2 PREPARATION BEFORE USE

Loading Batteries

- Remove the slide cover.
- Insert 2 new batteries (AAA type) following the (+) and (-) positions.

Clock Setup

- Push **CLOCK** by tip of the pencil.
If timer indication is flashing, go to the next step 2.

- Press **ON** or **SEE**: Adjust the time.
- Press **SET**: Set the time.

Remote Control Reset

Push **RESET** by tip of the pencil or

- Remove the batteries.
- Press **ON**.
- Insert the batteries.

Start/Stop

- Press **ON** to start operation.
(A receiving beep is heard)
- Press **OFF** to stop operation.
(A receiving beep is heard)

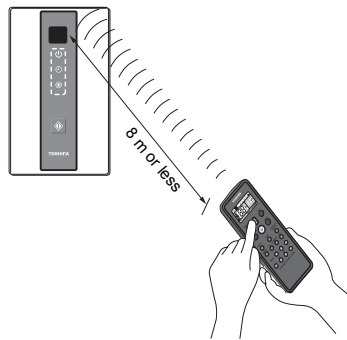
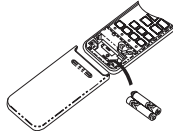

3 REMOTE CONTROL

- ① Infrared signal emitter
- ② Start/Stop button
- ③ Mode select button (MODE)
- ④ Temperature button (TEMP)
- ⑤ Fan speed button (FAN)
- ⑥ On timer button (ON)
- ⑦ Off timer button (OFF)
- ⑧ Setup button (SET)
- ⑨ Clear button (CLR)
- ⑩ Memory and Preset button (PRESET)
- ⑪ One-Touch button (ONE-TOUCH)
- ⑫ High power button (HI-POWER)
- ⑬ Economy button (ECO)
- ⑭ Quiet button (QUIET)
- ⑮ Comfort sleep button (COMFORT SLEEP)
- ⑯ Set clock button (CLOCK)
- ⑰ Check button (CHECK)
- ⑱ Reset button (RESET)

Note:

When pushing the "SWING", "FIX" and "FILTER" buttons, indoor unit does not operate and the receiving beep sound also not appear.

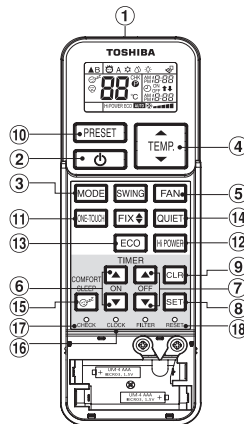

4 ONE-TOUCH

Press the "ONE-TOUCH" button for fully automated operation that is customized to the typical consumer preferences in your region of the world.

The customized settings control temperature, air flow strength and other settings to provide you alternate contact with "ONE-TOUCH" of the button. If you prefer other settings you can select from the many other operating functions of your Toshiba unit.

Press **ONE-TOUCH**: Start the operation.

5 AUTOMATIC OPERATION

To automatically select cooling or heating operation

- Press **MODE**: Select A.
- Press **TEMP**: Set the desired temperature.
- Press **FAN**: Select AUTO, LOW, LOW+, MED, MED+, or HIGH.

6 COOLING / HEATING OPERATION

- Press **MODE**: Select Cool or Heat.
- Press **TEMP**: Set the desired temperature.
- Press **FAN**: Select AUTO, LOW, LOW+, MED, MED+, or HIGH.

7 DRY OPERATION

For dehumidification, a moderate cooling performance is controlled automatically.

- Press **MODE**: Select Dry.
- Press **TEMP**: Set the desired temperature.

8 HI-POWER OPERATION

To automatically control room temperature and cooling (or heating) capacity for faster cooling (or heating) operation. (except in DRY mode)

Press **HI-POWER**: Start and stop the operation.

9 ECO OPERATION

To automatically control room to save energy (except in DRY mode)

Press **ECO**: Start and stop the operation.

Note: Cooling operation; the set temperature will increase automatically 1 degree/hour for 2 hours (maximum 2 degrees increase).

For heating operation the set temperature will decrease.

10 TEMPORARY OPERATION

In case of the misplaced or discharged remote control

- Pressing the TEMPORARY button, the unit can start or stop without using the remote control.
- Operation mode is set on AUTOMATIC operation, preset temperature is 24°C and fan operation is automatic speed.

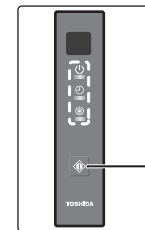

11 TIMER OPERATION

Set the timer when the air conditioner is operating.

	Setting the ON Timer	Setting the OFF Timer
1	Press ON : Set the desired ON timer.	Press OFF : Set the desired OFF timer.
2	Press SET : Set the timer.	Press SET : Set the timer.
3	Press CLR : Cancel the timer.	Press CLR : Cancel the timer.

Daily timer allows the user to set both the ON & OFF timers and will be activated on a daily basis.

Setting Everyday Timer

1	Press ON : Set the ON timer.	3	Press SET .
2	Press OFF : Set the OFF timer.	4	Press SET button during the (↑ or ↓) mark flashing.

- During the every day timer is activating, both arrows (↑, ↓) are indicated.

Note:

- Keep the remote control in accessible transmission to the signal receiving unit; otherwise, the time lag of up to 15 minutes will occur.
- The setting will be saved for the next same operation.

12 PRESET OPERATION

Set your preferred operation for future use. The setting will be memorized by the unit for future operation.

- Select your preferred operation.
- Press and hold **PRESET** for 3 seconds to memorize the setting. The **P** mark displays.
- Press **PRESET**: Operate the preset operation.

13 AUTO RESTART OPERATION

To automatically restart the air conditioner after the power failure (Power of the unit must be on.)

Setting

1. Press and hold the TEMPORARY button on the signal receiving unit for 3 seconds to set the operation. (3 beep sound and OPERATION lamp blink 5 time/sec for 5 seconds)
2. Press and hold the TEMPORARY button on the signal receiving unit for 3 seconds to cancel the operation. (3 beep sound but OPERATION lamp does not blink)

14 QUIET OPERATION

To operate at super low fan speed for quiet operation (except in DRY mode)

Press : Start and stop the operation.

Note: Under certain conditions, QUIET operation may not provide adequate cooling due to low sound features.

15 COMFORT SLEEP OPERATION

For comfortable sleep, automatically control air flow and automatically turn OFF.

Press : Select 1, 3, 5 or 9 hrs for OFF timer operation.

Note: The cooling operation, the set temperature will increase automatically 1 degree/hour for 2 hours (maximum 2 degrees increase). For heating operation, the set temperature will decrease.

16 SELF CLEANING OPERATION (COOL AND DRY OPERATION ONLY)

To protect bad smell caused by the humidity in the indoor unit.

1. If the button is pressed once during "Cool" or "Dry" mode, the fan will continue to run for other 30 minutes, then it will turn off automatically. This will reduce the moisture in the indoor unit.
If the time of "Cool" or "Dry" operation is less than 10 minutes, the self cleaning operation is not performed.
2. To stop the unit immediately, press the more 2 times within 30 seconds.

17 OPERATION AND PERFORMANCE

1. Three-minute protection feature: To prevent the unit from being activated for 3 minutes when suddenly restarted or switched to ON.
2. Preheating operation: Warm up the unit for 5 minutes before blowing warm air.
3. Warm air control: When the room temperature reaches the set temperature, the fan speed is automatically reduced and the outdoor unit will stop.
4. Automatic defrosting: Fans will stop during defrost operation.
5. Heating capacity: Heat is absorbed from outdoor and released into the room. When the outdoor temperature is too low, use another recommended heating apparatus in combination with the air conditioner.
6. Consideration for accumulated snow: Select the position for outdoor unit where it will not be subjected to snow drifts, accumulation of leaves or other seasonal debris.

Air conditioner operating conditions

Operation	Temp.	Outdoor Temperature	Room Temperature
Heating		※	Less than 28°C
Cooling		※	21°C ~ 32°C
Dry		※	17°C ~ 32°C

※ Refer to the Installation Manual of the outdoor unit.

18 TROUBLESHOOTING (CHECK POINT)

The unit does not operate.	Cooling or Heating is abnormally low.
<ul style="list-style-type: none"> • The power main switch is turned off. • The circuit breaker is activated to cut off the power supply. • Stoppage of electric current • ON timer is set. 	<ul style="list-style-type: none"> • The air filter (Locally procured) is blocked with dust. • The temperature has been set improperly. • The windows or doors are opened. • The air inlet or outlet of the outdoor unit is blocked. • The fan speed is too low. • The operation mode is DRY.

19 REMOTE CONTROL A-B SELECTION

To separate using of remote control for each indoor unit in case of 2 air conditioners are installed nearby.

Remote Control B Setup.

1. Press TEMPORARY button on the signal receiving unit to turn the air conditioner ON.
2. Point the remote control at the signal receiving unit.
3. Push and hold button on the Remote Control by the tip of the pencil. "00" will be shown on the display.
4. Press during pushing . "B" will show on the display and "00" will disappear and the air conditioner will turn OFF. The Remote Control B is memorized.

Note: 1. Repeat above step to reset Remote Control to be A.
2. Remote Control A has not "A" display.
3. Default setting of Remote Control from factory is A.

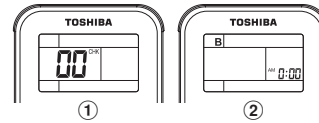

EN

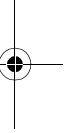
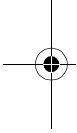
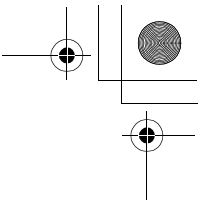
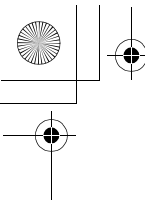

Toshiba Carrier Air Conditioning (China) Co., Ltd.

E0X7300401-00

